



GRK[®] FASTENERS[™]

GREATNESS AT EVERY TURN

GRK Fasteners offers a wide selection of fasteners that includes multipurpose, structural, deck, trim, cabinet, composite and stainless screws, but they all have one thing in common—quality.

GRK Fasteners allows users to complete jobs with more productivity. Our patented W-Cut[™] Threadform feature reduces installation torque and allows fast driving and ease of install, the recessed Star Drive eliminates recess stripping for improved productivity, and the Zip-Tip[™] feature eliminates the need for pre-drilling and allows one-step installation. GRK's feature-rich screws drive jobsite productivity and allow users to keep moving from one job to the next.

GRK fasteners are corrosion resistant, approved for use in treated lumber and designed for both interior and exterior use.



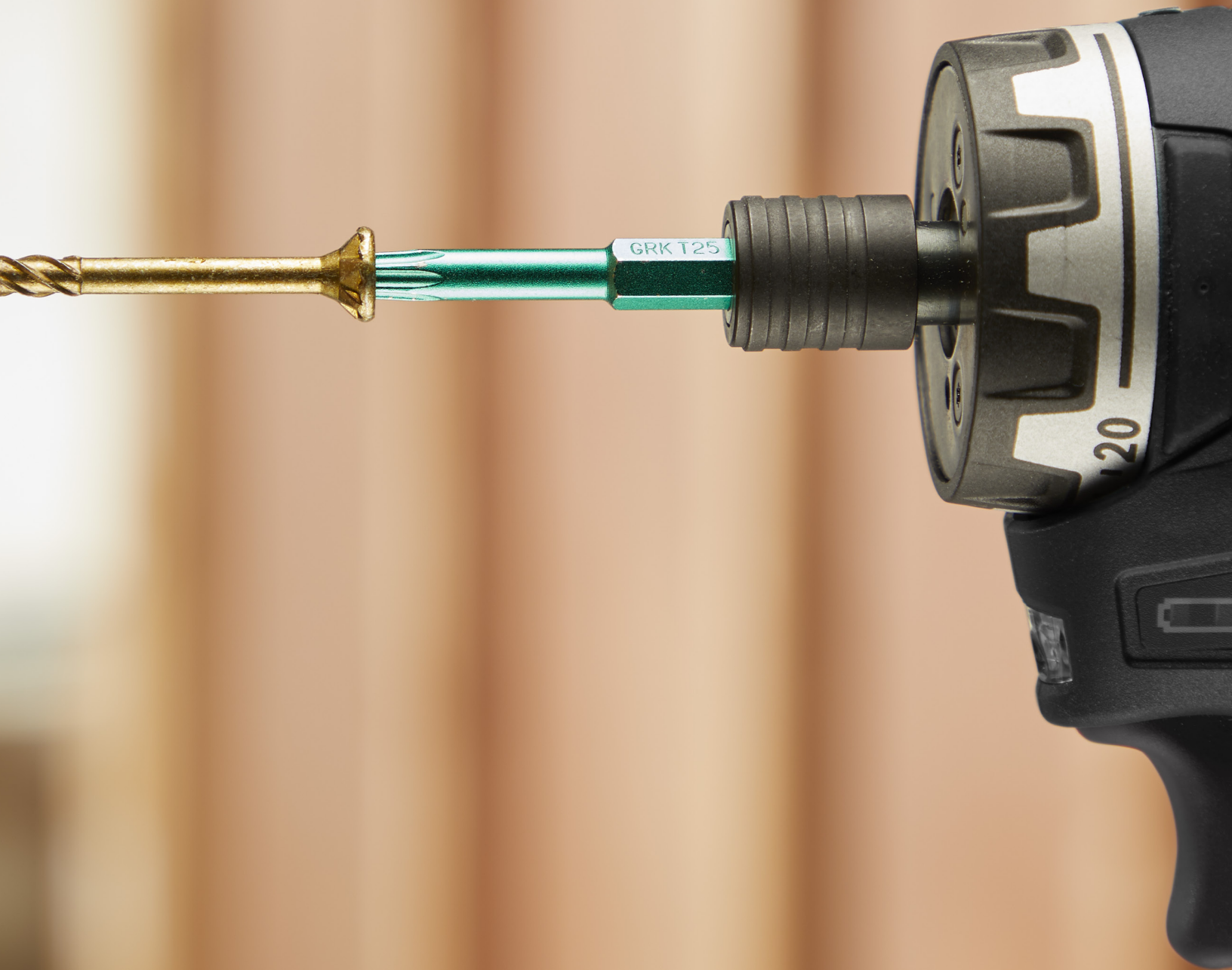

R4™ MULTI-PURPOSE FRAMING & DECKING SCREWS



FASTER DRIVE FOR IMPROVED PRODUCTIVITY

GRK's R4™ Multi-purpose Screw is a versatile, code-approved fastener for hundreds of applications. Its feature-rich design provides a fast and reliable connection every time.

- **Fast Bite Tip:** Provides a fast start for one-step installation
- **Zip-Tip™:** Eliminates pre-drilling
- **W-Cut™:** Low torque, faster drive
- **Precision Fit:** Reduces wobble between R4 screws and GRK bits for improved productivity¹
- **CEE Thread™:** Enlarges hole to reduce splitting²
- **Star Drive Recess:** Zero stripping, with 6 points of contact
- **Underhead Cutting Teeth:** Cuts wood fiber & provides flush seating
- **GRK Head Markings:** Easy identification of genuine GRK screws
- **Climatek™ Coating:** ICC-ES AC257 code approved for use in treated lumber³
- **Code Approved:** For structural applications (see ESR-3201)⁴
- Some sizes also available in PHEINOX™ 305 and 316 grade Stainless Steel • For interior / exterior use



ESR-3201



AC257 Treated
Lumber Approved

1. Precision Fit included on #9 and #10 sizes only
2. CEE Thread included on fasteners 2" and longer
3. For cedar, redwood and other naturally protected woods, GRK Pheinox™ 305 and 316 stainless steel is recommended
4. ICC Code Approval for #9, #10, and #12 sizes only

	U.S. (Std.) Size (Dia. x Length)	Bulk Part No.	Bulk Box Qty.	Contractor Packs (XL buckets) Part No.	Contractor Packs (XL buckets) Qty.	Pro Pack Part No.	Pro Pack Pail Qty.	Handy Pack Part No.	Handy Pack MC Qty./ Screw Qty. (per EA)
T-15	#6 x 1-1/4"	00051	13,000						
	#8 x 1-1/4"					01069	1,300	96080	4 / 110
T-15	#8 x 1-1/2"	00073	6,500			01073	1,000	96085	4 / 110
	#8 x 1-3/4"					01075	925	02075	20 / 100
	#8 x 2"	00077	4,500			01077	850	02077	20 / 100
	#8 x 2-1/2"	00079	3,500			01079	650	02079	20 / 100
T-25	#9 x 1-1/4"	00091	8,000						
	#9 x 1-1/2"	00095	5,200			01095	820	02095	20 / 100
	#9 x 1-3/4"	00097	4,500						
	#9 x 2"	00099	3,700	120990	990	01099	690	103099	4 / 110
	#9 x 2-1/2"	00101	2,900	121010	900	01101	575	103101	4 / 100
	#9 x 2-3/4"	00103	2,000			01103	480	02103	10 / 100
	#9 x 3-1/8"	00105	1,900	121050	720	01105	425	103105	4 / 80
T-25	#10 x 2"	00131	3,200						
	#10 x 2-1/2"	00133	2,500			01133	470	103133	4 / 80
	#10 x 2-3/4"	00135	2,000						
	#10 x 3-1/8"	00137	1,500	95200	630	01137	350	103137	4 / 70
	#10 x 3-1/2"	00139	1,200			01139	300	02139	10 / 50
	#10 x 4"	00141	1,000	121410	450	01141	270	103141	4 / 50
	#10 x 4-3/4"	00143	800			01143	230	02143	10 / 50
T-25	#12/14 x 5-5/8"	00173	600					96089	4 / 50
	#12/14 x 6-3/8"	00177	1,000					02177	9 / 50
	#12/14 x 8"	00181	500					02181	9 / 50



APPLICATIONS:

- Multi-Purpose Framing
- Interior and Exterior Remodeling
- Porches and Patios
- Fencing
- Exterior Structures

- Pro Packs need to be ordered in multiples of two
- 2" bit included in Pro Packs. 1" bit with Handy Packs

RSS™ STRUCTURAL RUGGED STRUCTURAL SCREWS



EASY TO INSTALL LAG ALTERNATIVE

GRK's RSS™ Rugged Structural Screw is a structural fastener designed for ease of installation and the strongest of connections. RSS fasteners drive into most woods without the need for pre-drilling. The specially engineered design results in a low-effort installation, especially compared to conventional lag screws.

- **Fast Bite Tip:** Provides a fast start for one-step installation
- **Zip-Tip™:** Eliminates pre-drilling¹
- **W-Cut™:** Low torque, faster drive
- **Precision Fit:** Reduces wobble between RSS screws and GRK bits for improved productivity²
- **Integrated Washer Head:** Maximum clamping force
- **Star Drive Recess:** Zero stripping, with 6 points of contact
- **GRK Head Markings:** Easy identification of genuine GRK screws
- **CEE Thread™:** Enlarges hole to reduce splitting³
- **Climatek™ Coating:** ICC-ES AC257 code approved for use in treated lumber³
- **Code Approved:** For structural applications (see ESR-2442)⁴
- Some sizes also available in PHEINOX™ 305 and 316 grade Stainless Steel • For interior / exterior use







ESR-2442



AC257 Treated
Lumber Approved

1. Zip-Tip included on fasteners 2-1/2" and longer
2. Precision Fit included on 5/16" sizes only
3. CEE Thread included on fasteners 3-1/8" and longer
4. For cedar, redwood and other naturally protected woods, GRK Pheinox™ 305 and 316 stainless steel is recommended
5. ICC Code Approval for 1/4", 5/16", and 3/8" sizes only

	U.S (Std.) Size (Dia. x Length)	Bulk Part No.	Bulk Box Qty.	Pro Pack Part No.	Pro Pack Qty.	Handy Pack Part No.	Handy Pack MC Qty./ Screw Qty. (per EA)	Individually Tagged Part No.	Individually Tagged (Qty./Ctn.)
 T-25	#10 x 2-1/2"	10133	1,000	11137	236	12133	10 / 50		
	#10 x 3-1/8"	10137	800			12137	10 / 50		
 T-25	1/4" x 1-1/2"	10151	1,000			12151	20 / 50		
	1/4" x 2"	10155	800			12155	10 / 50		
	1/4" x 2-1/2"	10157	700					90305	1 / 75
	1/4" x 3-1/2"							90306	1 / 75
	1/4" x 3-1/8"	10161	500			12161	10 / 50		
 T-30	5/16" x 2-1/2"	10217	600			12217	9 / 100		
	5/16" x 2-3/4"	10219	500	12219	2 / 100				
	5/16" x 3-1/8"	10221	500	12221	2 / 100	14221	10 / 25	96001	1 / 50
	5/16" x 3-1/2"	10223	500	12223	2 / 100	95307	4 / 45	90307	1 / 50
	5/16" x 4"	10225	400	12225	2 / 100	14425	10 / 25	96005	1 / 50
	5/16" x 5-1/8"	10231	300	12231	9 / 50	14235	10 / 25	96010	1 / 50
	5/16" x 6"	10235	300	12235	9 / 50	14235	10 / 25	96015	1 / 40
 T-40	3/8" x 3-1/8"	10273	400						
	3/8" x 4"	10275	400	12275	9 / 50				
	3/8" x 6"	10281	300	12281	2 / 50				
	3/8" x 7-1/4"	10285	200	12285	2 / 50				
	3/8" x 8"	10287	300	12287	2 / 50			96020	1 / 25
	3/8" x 10"	10293	300	12293	2 / 50			96025	1 / 25
	3/8" x 12"	10299	300	12299	2 / 50			96030	1 / 20
	3/8" x 14-1/8"			12307	2 / 50				
	3/8" x 16"	10311	100	12311	2 / 50				
RSS[™] JTS - JOIST AND TRUSS SCREW									
 T-25	1/4" x 5"					93735	9 / 50		
	1/4" x 6-3/4"	91743	300			93743	9 / 50		

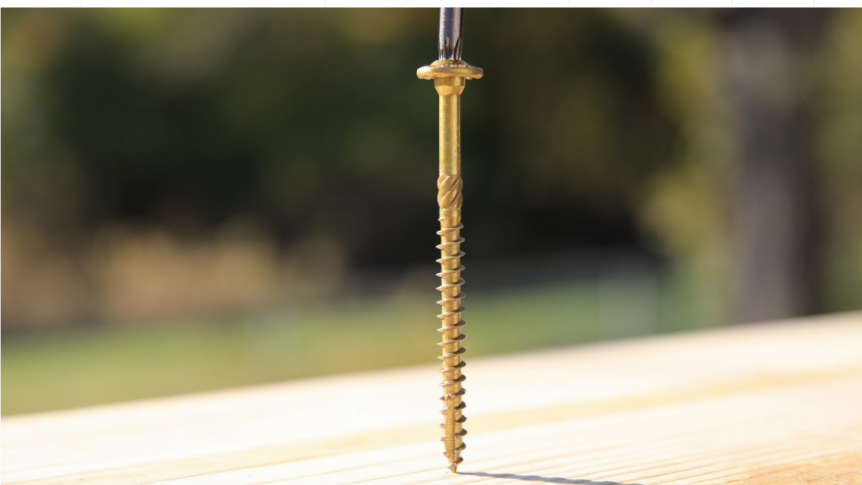

APPLICATIONS:

- Structural Decking
- Heavy Duty Framing
- LVL Fastening
- Ledger Boards
- Multi-ply
- Interior and Exterior Remodeling

- Pro Packs need to be ordered in multiples of two
- 2" bit included in Pro Packs. 1" bit with Handy Packs

DECK ELITE

DECKING SCREWS



SPEED. QUALITY. ELEVATED CRAFTSMANSHIP

GRK's Deck Elite screws are designed for use in wood deck boards and provide a quick drive and clean finish. Deck Elite screws start immediately in wood with a smooth, fast drive to increase productivity on the job and the tan color of the screw provides an ideal finish.

- **Tan Color:** Provides an ideal finish
- **Fast Bite Tip:** Provides a fast start for one-step installation
- **Zip-Tip™:** Eliminates pre-drilling
- **W-Cut™:** Low torque, faster drive
- **CEE Thread™:** Enlarges hole to reduce splitting¹
- **Star Drive Recess:** Zero stripping, with 6 points of contact
- **GRK Head Markings:** Easy identification of genuine GRK screws
- **Corrosion Resistant Coating:** Resists rust and keeps decks looking new
- For use in wood deck boards, fencing, and deck rails, including pressure treated lumber²
- For interior / exterior use

1. CEE Thread included on fasteners 2" and longer
2. For cedar, redwood and other naturally protected woods, GRK Pheinox™ 305 and 316 stainless steel is recommended

	U.S (Std.) Size (Dia. x Length)	Contractor Packs (XL buckets) Part No.	Contractor Packs (XL buckets) Qty.	Pro Pack Part No.	Pro Pack Pail Qty.
 T-15	#8 x 2	40803	1,080	10803	540
	#9 x 1-5/8"	49159	1,080	19159	540
 T-25	#9 x 2-1/2"	49212	800	19212	400
	#9 x 3"	40903	700	10903	350

- Contractor Packs and Pro Packs need to be ordered in multiples of two
- 2" bit included in Pro Packs. 1" bit with Contractor Packs



APPLICATIONS:

- Deck Boards
- Fencing
- Deck Rails

FIN/TRIM™

FINISHING TRIM HEAD SCREWS

PROFESSIONAL FINISH, PROFESSIONAL LOOK

GRK's Fin/Trim™ screws are an excellent choice for most fine carpentry applications, as well as window extension jambs, joining cabinets and more. A combination of the smallest screw head available and code approved structural performance means the most secure, concealed fastening in the industry.

- **Trim Head:** Clean, finished look
- **Star Drive Recess:** Zero stripping, with 6 points of contact
- **W-Cut™:** Low torque, faster drive
- **Zip-Tip™:** Eliminates pre-drilling
- **Climatek™ Coating:** ICC-ES AC257 code approved for use in treated lumber¹
- **Code Approved:** For structural applications (see ESR-3201)
- Some sizes also available in PHEINOX™ 305 and 316 grade Stainless Steel• For interior / exterior use

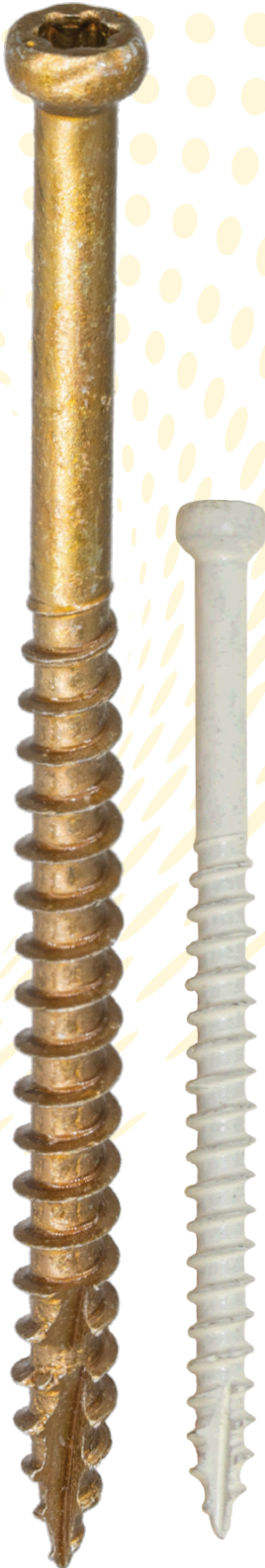



ESR-3201



AC257 Treated
Lumber Approved

1. For cedar, redwood, and other naturally-protected woods, GRK recommends PHEINOX™ stainless steel fasteners

	U.S (Std.) Size (Dia. x Length)	Bulk Part No.	Bulk Box Qty.	Pro Pack Part No.	Pro Pack Pail Qty.	Handy Pack Part No.	Handy Pack MC Qty./Screw Qty. (per EA)
 T-10	#8 x 1-1/4"					96055	6 / 100
	#8 x 1-1/2"	15724	6,500	116724	600	119724	6 / 100
	#8 x 2"	15728	4,500	116728	510	119728	6 / 100
	#8 x 2-1/2"	15730	3,500	16730	605	119730	6 / 100
	#8 x 2-3/4"					17732	20 / 100
	#8 x 3-1/8"	15734	2,500	115734	300	119734	6 / 100
 T-15	#9 x 4"	15760	1,000			117760	4 / 50
	#9 x 5"	15766	800			117766	4 / 50
White Fin/Trim[™]							
 T-10	#8 x 2"			16828	605	96060	4 / 100
	#8 x 2-1/2"			16830	505	96065	4 / 100

- Pro Packs need to be ordered in multiples of two
- 2" bit included in Pro Packs. 1" bit with Handy Packs



APPLICATIONS:

- Trim Work
- Cabinets
- Fine Carpentry

RT COMPOSITE™

EXTERIOR TRIM SCREW

INSTALL RIGHT THE FIRST TIME

The RT Composite™ screw is a specially designed fastener for attaching composite and cellular PVC materials. Reverse threading under the head of the fastener helps the screw head disappear beneath the surface of the classic wood composite material while reducing or eliminating the dimple that is common in this substrate.

- **Trim Head:** Clean, finished look
- **Underhead Reverse Thread:** Reduces or eliminates mushrooming
- **Star Drive Recess:** Zero stripping, with 6 points of contact
- **W-Cut™:** Low torque, faster drive
- **Zip-Tip™:** Eliminates pre-drilling
- **Climatek™ Coating:** ICC-ES AC257 code approved for use in treated lumber¹
- Available in Climatek or White Climatek coated finish
- Some sizes also available in PHEINOX™ 305 and 316 grade Stainless Steel• For interior / exterior use



ESR-3201



AC257 Treated
Lumber Approved

1. For cedar, redwood, and other naturally-protected woods, GRK recommends PHEINOX™ stainless steel fasteners



T-10



T-15

U.S (Std.) Size (Dia. x Length)	Bulk Part No.	Bulk Box Qty.	Pro Pack Part No.	Pro Pack Pail Qty.	Handy Pack Part No.	Handy Pack MC Qty./Screw Qty. (per EA)
#8 x 2"			16077	725	119077	6 / 100
#8 x 2-1/2"	15079	3,500	16079	605	119079	6 / 100
#8 x 3-1/8"	15083	2,500	16083	514	119083	6 / 100
#9 x 2-1/2"	15101	2,900	16101	408		
#9 x 3-1/8"	15105	1,900	16105	348		

White RT Composite™



T-10

#8 x 2"			16628	605	17628	20 / 100
#8 x 2-1/2"			16630	505	96075	4 / 100
#8 x 2-3/4"					17632	20 / 100
#8 x 3-1/8"					17634	10 / 100

- Pro Packs need to be ordered in multiples of two
- 2" bit included in Pro Packs. 1" bit with Handy Packs



APPLICATIONS:

- Exterior Trim
- cPVC Deck Boards
- Hidden Fastening Systems

PHEINOX™ STAINLESS STEEL SCREWS

PHEINOX™ 305 CORROSION RESISTANCE FOR HIGH MOISTURE ENVIRONMENTS

PHEINOX™ 316 MARINE GRADE PROTECTION FOR SUPERIOR CORROSION RESISTANCE



GRK's PHEINOX™ line of stainless steel fasteners feature designs from R4, RSS, Fin/Trim, and RT Composite screws in corrosion and stain resistant material.

GRK recommends PHEINOX™ 305 stainless steels screws for applications that require superior corrosion resistance in exterior environments with high moisture content, such as docks, boardwalks, pools, and hot tubs. PHEINOX™ 305 stainless is also recommended for use with cedar, redwood and various other wood species that have higher acid content. PHEINOX™ 305 stainless steels screws are recommended for applications located more than 1 mile from the coast.

PHEINOX™ 316 stainless steels screws are recommended for applications where extreme corrosion resistance is necessary, such as environments with high exposure to chlorides- such as de-icing salts- and in coastal applications within 1 mile of the coast. They are also suitable for use in chemically treated wood and naturally-protected wood such as cedar and redwood.

PHEINOX™ 305 Stainless Steel

- For use in cedar, redwood, specialty hardwood, IPE, and Mangaris
- Corrosion resistance for wet environments
- Stain resistant in specialty wood

PHEINOX™ 316 Stainless Steel

- For use within 1 mile of the coast
- Marine-Grade protection for superior corrosion resistance
- Superior Corrosion resistance for coastal environments
- Stain resistant in specialty wood



ESR-2442



ESR-3201



AC257 Treated
Lumber Approved



T-25

U.S. (Std.) Size (Dia. x Length)	Bulk Part No.	Bulk Box Qty.	Pro Pack Part No.	Pro Pack Pail Qty.	Handy Pack Part No.	Handy Pack MC Qty./Screw Qty. (per EA)
R4™ Screws: PHEINOX™ 305						
#10 x 2-1/2"	25133	2,500	61633	240	61733	4 / 80
#10 x 3-1/8"	25137	1,500	61637	210	61737	4 / 70



T-30

RSS™ Screws: PHEINOX™ 305						
5/16" x 3-1/8"	30221	500			62225	4 / 45
5/16" x 4"	30225	400			132231	4 / 40
5/16" x 5-1/8"						
5/16" x 6"	30235	300				



T-10

RT COMPOSITE™ Trim Screws: PHEINOX™ 305						
#8 x 2"			36077	600		
#8 x 2-1/2"	35079	3,500	36079	560	37079	20 / 100
#9 x 2-1/2"			36101	365		



T-15

FIN / TRIM™ Screws: PHEINOX™ 305						
#8 x 1-1/2"					37724	20 / 100
#8 x 2"			61728	510	67728	6 / 100
#8 x 2-1/2"			61730	420	67730	6 / 100
#8 x 3-1/8"			36734	385	37734	10 / 100
#9 x 2-1/2"			36752	365		



T-10



T-15

R4™ Screws: PHEINOX™ 316						
#10 x 2-1/2"					137133	4 / 80
#10 x 3-1/8"					137147	4 / 70



T-25

FIN / TRIM™ Screws: PHEINOX™ 316						
#8 x 2-1/2"					147730	6 / 100



T-10

• 2" bit included in Pro Packs. 1" bit with Handy Packs



APPLICATIONS:

- Boardwalks
- Pool Decks
- Spas

LOW PROFILE CABINET™

CABINET SCREWS



QUICK AND SECURE INSTALLATION

GRK's Cabinet screws are designed for use in cabinet construction and installation. Cabinet screws are manufactured in a #8 gauge (4 mm) diameter for universal size convenience.

- **Star Drive Recess:** Zero stripping, with 6 points of contact
- **Zip-Tip™:** Eliminates pre-drilling¹
- **W-Cut™:** Low torque, faster drive
- **Washer Head:** Creates a flush, clean hold for a strong and secure installation
- **Climatek™ Coating:** ICC-ES AC257 code approved for use in treated lumber²
- **White Cabinet Coating:** Color matched for interior applications
- For interior / exterior³ use



**AC257 Treated
Lumber Approved**

1. Zip-Tip included on fasteners 1-1/4" and longer
2. For cedar, redwood, and other naturally-protected woods, GRK recommends PHEINOX™ stainless steel fasteners
3. White Cabinet Coating only suitable for interior use



T-15

U.S (Std.) Size (Dia. x Length)	Bulk Part No.	Bulk Box Qty.	Pro Pack Part No.	Pro Pack Pail Qty.	Handy Pack Part No.	Handy Pack MC Qty./Screw Qty. (per EA)
#8 x 1"					96050	6 / 100
#8 x 1-1/4"	10069	4,000	100069	330	114069	6 / 100
#8 x 1-1/2"	10073	3,000	100073	330	114073	6 / 100
#8 x 1-3/4"	10075	2,000			12075	10 / 100
#8 x 2"	10077	2,000	96077	330	113077	4 / 100
#8 x 2-1/2"	10079	1,500	110079	330	113079	4 / 100
#8 x 2-3/4"					113081	4 / 100
#8 x 3-1/8"	10083	1,000	110083	270	114083	6 / 50

White Low Profile[™] Cabinet Screws



T-15

#8 x 1-1/4"					120680	6 / 80
#8 x 1-1/2"					120670	6 / 80
#8 x 2-1/2"					120660	6 / 80

- Pro Packs need to be ordered in multiples of two
- 2" bit included in Pro Packs



APPLICATIONS:

- Cabinet Construction & Installations
- Trim & Moulding
- Light-Duty Framing

TOP STAR™

ADJUSTABLE SHIM SCREWS



FOR PLUMB INSTALLATION OF WOODEN DOORS AND WINDOWS. NO MORE SHIMS!

GRK's adjustable Top Star™ shim screw is a screw within a screw that allows you to install wooden doors or windows without the use of shims. The quick and easy system reduces labor and allows for hassle free adjustment to ensure plumb installation.

The 4-point top sleeve provides a secure hold into the frame, while the GRK Star Drive bit is used to make the adjustments needed for a perfect, shim-free installation.

The Top Star's highly-engineered system can be used for installation of wooden doors, windows, insulation, paneling, wall-units, and cabinets.

- **Recessed Star Drive:** Zero stripping, with 6 points of contact
- **4-point 3/8" Diameter Threaded Sleeve** provides a secure hold in your wooden frame
- **Micro-Adjustments** allow for an absolute plumb installation
- **Use with GRK's Top Star™ Crown and T-15 Star Bit System**
- **Zinc Plated** finish for lasting durability
- **For Shim Free Installation** of wooden doors, windows, insulations, paneling, built-in wall units, and cabinets

U.S (Std.) Size (Dia. x Length)	Pro Pack Part No.	Pro Pack Pail Qty.
3/8" x 2-1/2"	20157	100
3/8" x 3-1/8"	20161	100

• Pro Packs need to be ordered in multiples of two

The Complete Top Star™ System Includes:

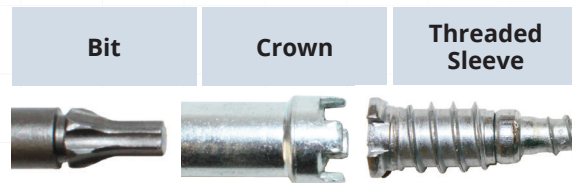

Crown / Bit	Blister Pack Part No.	Blister Pack Qty.
Includes: (1) Crown / Bit with each	86465	1

• 5/16" drill bit not included

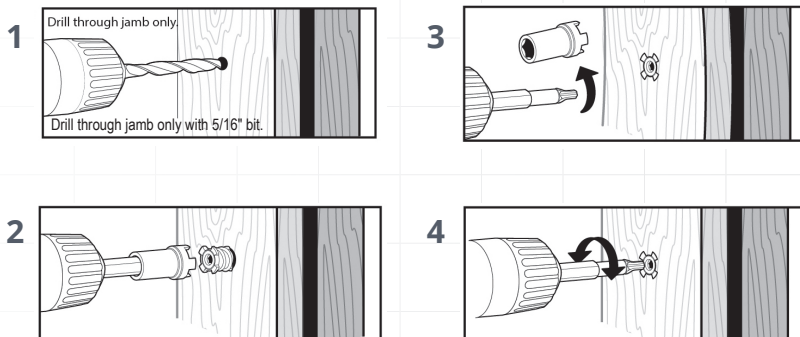

The Bit drives the Top Star™ into the material when the Crown and Bit are combined. Using the Bit without the Crown adjusts the distance.

The Threaded Sleeve moves independently from the Top Star™ unless locked by the Crown. When locked, the Top Star™ gets driven into the material.

Unlocked, the installed Top Star™ is ready for leveling.



APPLICATIONS:

- Wooden Doors
- Windows
- Insulation

CALIBURN™ CONCRETE SCREW



HEAVY DUTY CONCRETE AND MASONRY FASTENER

Caliburn™ Concrete screws are professionally engineered fasteners with a patented thread design for ease of driving the screw into concrete and similar applications.

- **Star Drive Recess:** Zero stripping, with 6 points of contact
- **Aggressive Heavy Duty Threads** lock into concrete and can be removed/reinserted without screw damage
- **Caliburn™ XL:** washer head design for superior holding power
- **Climatek™ Coating:** ICC-ES AC257 code approved for use in treated lumber
- Ideal for use in anchoring to concrete or wood to concrete applications including basement framing and sheds

APPLICATIONS:

- Wood to Concrete Framing
- Electrical and Plumbing Fixtures
- Caliburn XL for Heavy Duty Concrete Anchoring



U.S (Std.) Size (Dia. x Length)	Bulk Part No.	Bulk Box Qty.	Handy Pack Part No.	Handy Pack MC Qty./Screw Qty. (per EA)
Caliburn™ XL				
19/64" x 2-3/4"			57774	10 / 25
19/64" x 3-1/2"	55778	400	57778	10 / 25
19/64" x 5"			57785	10 / 25

• 1" bit included in Handy Packs

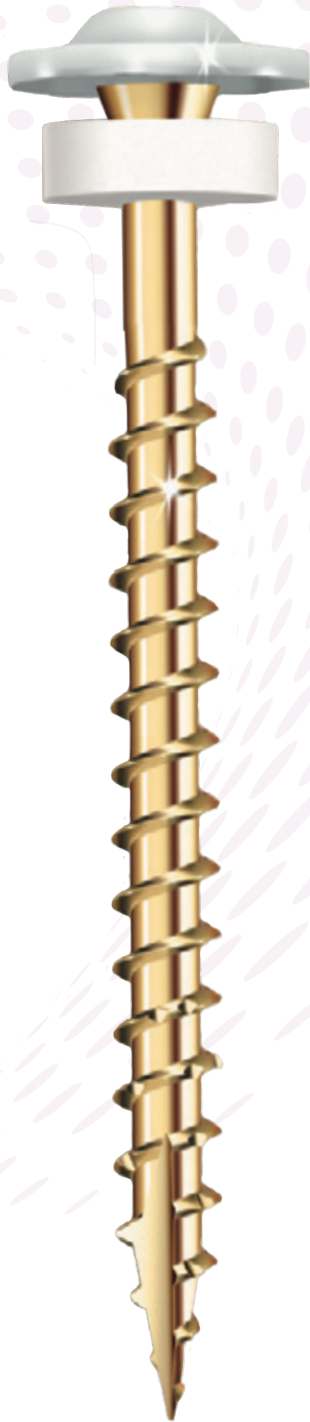

POWDER COATED HEAD FOR A CLEAN FINISHED LOOK

This screw has an integrated washer-head and is complemented by a rubber washer below the screw head. This feature also helps protect the washer from prolonged exposure to the sun for long lasting, secure siding installations.

- **White Color, Low Profile Head** produces a clean, finished look which is preferred for moldings, closet organizers, and metal siding
- **Washer Head** increases holding power
- **Rubber Washer:** seals drill hole from the elements
- **W-Cut™ Thread Design** tiny saw blades reduce torque by cutting through the material
- **ZIP-TIP™** for easy starts and no pre-drilling
- For use in interior or exterior applications including metal siding, garage door trim, and even closet organizers. Not for use with treated lumber

APPLICATIONS:

- Metal Siding
- Garage Door Trim
- Closet Organizers



T-25

U.S (Std.) Size (Dia. x Length)	Bulk Part No.	Bulk Box Qty.
#9 x 1-1/2"	40090	3000

- 1" bit included in Handy Packs

STAR DRIVE BITS

CROWN / BIT



Bit Size	Bit Color	Fits	Bulk Part No.	Bulk Box Qty.	Carded Part No.	Carded Qty/per pack
T-10 2" T-10 3"	Yellow Yellow	Trim™ Head #8	86419	25	187419 87421	2 2
T-15 2" T-15 3"	Red Red	R4™ Screw #6 & 8 Trim™ Head #9 Cabinet™ Screw	86427	25	187427 87429	2 2
T-20 2"	Purple		86435	25	187435	2
T-25 2" T-25 3"	Green Green	R4™ #9,10 & 12 RSS™ #10 & 1/4" MSS™ #9	86443	25	187443 87445	2 2
T-30 2" T-30 3"	Black Black	RSS™ Structural Screw 5/16" Caliburn™ & Caliburn PH™	86451	25	187451 87453	2 2
T-40 2"	Blue	Caliburn XL™ Screws RSS™ Structural Screw 3/8"	86459	25	187459	2

Crown/Bit						
		TOP STAR™			86465	1





STAR DRIVE BITS & ACCESSORIES



Tapcon®

 **DRIVING CONCRETE CONNECTIONS**

Tapcon® is the #1 recognized screw anchor brand in the industry. For decades, Tapcon has helped professionals get their concrete anchoring jobs done right the first time, every time.

The blue, corrosion-resistant coating enables our anchors to withstand the harshest conditions, and their unmatched performance (30% less torque and 20% more holding power) in concrete, block and brick applications make them an excellent alternative to expansion anchors, plugs and lag shields.

For quality, strength, and ease of installation, nobody matches the confidence pros get from using the original true blue screw.





TAPCON®

CONCRETE SCREW ANCHORS



NOTHING ANCHORS LIKE A TAPCON.

Tapcon concrete anchors deliver the ease of use, superior precision, and unparalleled performance that professionals demand.

- **Eliminate bit slips** and increase productivity with star recess on flat head Tapcon anchors
- **Resist head snaps** and spin outs with under-head ribs on hex head Tapcon anchors
- **Superior holding strength** for confidence in a job done right
- **Corrosion resistant**, long lasting performance with Climaseal™ coating
- **WERCS threadform** allows for easy installation across a variety of masonry substrates
- **ICC-ES** recognized for use in concrete and masonry (ESR-2202 & ESR-1671)

APPLICATIONS:

Star Head

- Furring Strips
- Wood Framing
- Window Frames

Hex Head

- Electrical Boxes



ESR-1671



ESR-2202



U.S (Std.) Size (Dia. x Length)	Bucket Part No.	Bucket Qty.	Lg. Clam Part No.	Lg. Clam Qty.	Med. Pack Part No.	Med. Pack Qty.	Small Pack Part No.	Small Pack Qty.
STAR HEAD								
3/16" x 1-1/4"	28550	225	28350	75	28250	25	28150	8
3/16" x 1-3/4"	28555	225	28355	75	28255	25	28155	8
3/16" x 2-1/4"	28560	225	28360	75	28260	25	28160	8
3/16" x 2-3/4"	28565	225	28365	75	28265	25	28165	8
3/16" x 3-1/4"			28307	75			28107	8
1/4" x 1-3/4"	28575	225	28375	75	28275	25	28175	8
1/4" x 2-1/4"			28380	75	28280	25	28180	8
1/4" x 2-3/4"	28585	150	28385	75	28285	25	28185	8
1/4" x 3-3/4"			28395	75	28390	25	28295	8
1/4" x 4"			28304	50	28397	25	28204	8
HEX HEAD								
3/16" x 1-1/4"			24300	75	24200	25	24100	8
3/16" x 1-3/4"			24305	75	24205	25	24105	8
3/16" x 2-3/4"			24310	75	24210	25	24110	8
1/4" x 1-1/4"	24515	225	24315	75	24215	25	24115	8
1/4" x 1-3/4"	24520	225	24320	75	24220	25	24120	8
1/4" x 2-1/4"	24525	225	24325	75	24225	25	24125	8
1/4" x 2-3/4"	24530	150	24330	75	24230	25	24130	8
1/4" x 3-1/4"	24501	150	24301	75			24101	8
1/4" x 3-3/4"			24340	75	24335	25		
1/4" x 4"					24345	25		
WHITE ULTRASHIELD TAPCON								
3/16" x 1-3/4"			28371	75			28171	8
3/16" x 2-1/4"			28372	75			28172	8
3/16" x 2-3/4"			28367	75	28267	25	28167	8
1/4" x 2-3/4"			24388	75	24288	25	24188	8
1/4" x 3-1/4"			24391	75				
1/4" x 3-3/4"			24392	75				
410 STAINLESS STEEL TAPCON								
3/16" x 1-3/4"							26155	8
3/16" x 2-3/4"							26165	8
1/4" x 1-3/4"							26120	8
1/4" x 2-3/4"							26130	8
MAXI-SET TAPCON								
1/4" x 2-1/4"			24326	50				
1/4" x 2-1/4"			24323	50				
TAPCON DRILL BITS								
5/32" x 3-1/2"							11256	1
5/32" x 4-1/2"							11247	1
5/32" x 5-1/2"					11249	4	11363	1
3/16" x 3-1/2"							11257	1
3/16" x 4-1/2"							11248	1
3/16" x 5-1/2"					11250	4	11362	1
5/32" x 7" SDS							11492	1
3/16" x 7" SDS							11491	1
1/4" x 7" SDS							11493	1
3/8" x 8" SDS							11494	1
1/2" x 10" SDS							11495	1
TAPCON PRO INSTALLATION KIT								
Tapcon Pro Install Tool							79013	1

TAPCON® CONCRETE SCREW ANCHORS

TAPCON+®

HEAVY DUTY CONCRETE SCREW ANCHORS



STRONGER. FASTER. EASIER.

Tapcon+ unmatched performance in concrete, block and brick applications make them an excellent alternative to expansion anchors, plugs, lag shields and have a blue corrosion resistant coating that enables them to withstand the harshest conditions. That's why when pros look for quality, strength and ease of installation, they choose Tapcon.

- **ICC-ES Approved** for use in uncracked & cracked concrete and seismic conditions (ESR-3699)
- **Heavy-Duty Holding Power** in all concrete conditions
- **Flexibility:** to install closer to the edge & closer together with confidence
- **Precision Fit:** A long-standing reputation for quality, strength, and ease of installation from industry professionals



ESR-3699

U.S (Std.) Size (Dia. x Length)	Pro Pack Part No.	Pro Pack Qty.	Handy Pack Part No.	Pro Pack Pail Qty.	Small Pack Part No.	Small Pack Qty.
5/16" x 2-1/4"			24292	15	24192	4
5/16" x 3"			24293	15	24193	4
3/8" x 1-3/4"	11440	10			50440	2
3/8" x 2-1/4"	11441	10			50441	2
3/8" x 3"	11413	10			50403	2
3/8" x 4"	11414	10			50404	2
3/8" x 5"					50445	2
3/8" x 6"					50446	2
1/2" x 3"	11447	10			50447	2
1/2" x 4"	11420	10			50408	2
1/2" x 5"	11449	10			50449	2
1/2" x 6"	11421	10			50426	2



APPLICATIONS:

- Sill Plates
- Post Cap Connector
- Ledger Board
- Heavy Equipment
- Industrial Racking/Shelving
- Modular Walls
- Machinery

Trubolt WEDGE ANCHORS

HEAVY DUTY CONCRETE ANCHORS



MAXIMUM STRENGTH FOR HEAVY-DUTY CONCRETE ANCHORING

Trubolt Wedge Anchors offer maximum strength and ultimate flexibility making them the PRO choice for heavy-duty anchoring. This wedge anchor features a high-strength body that is built to resist tension and shear loads.

- **ICC-ES Approved** for use in uncracked concrete (ICC-ES-ESR-2251)
- **Heavy-Duty Holding Power** in concrete conditions
- **Fully Threaded Anchor Design** for application versatility
- **Stainless Steel Clip** provides extra corrosion protection
- A long standing reputation for quality, strength, and ease of installation from industry professionals



ESR-2251

U.S (Std.) Size (Dia. x Length)	Pro Pack Part No.	Pro Pack Qty.	Handy Pack Part No.	Handy Pack Pail Qty.	Poly-Bag Part No.	Poly-Bag Qty.
1/4" x 2-1/4"			12377	25	50080	1
3/8" x 2-1/4"	12367	50	12015	15	50081	1
3/8" x 3"	03014	50			50082	1
3/8" x 3-3/4"	12370	50	12016	15	50083	1
3/8" x 5"			12022	15	50084	1
1/2" x 2-3/4"					50085	1
1/2" x 3-3/4"	12371	25	12017	10	50181	1
1/2" x 4-1/4"	12372	25	12020	10	50086	1
1/2" x 5-1/2"	12373	25	12019	10	50087	1
1/2" x 7"					50088	1
5/8" x 5"	12310	10			50089	1
5/8" x 6"	03041	10				
5/8" x 7"	03044	10			51030	1
5/8" x 8-1/2"					50305	1
3/4" x 5-1/2"	02992	10			51001	1
HOT-DIPPED GALVANIZED						
1/2" x 5-1/2" HDG			12021	10	50303	1
1/2" x 7" HDG	12029	10			50307	1



APPLICATIONS:

- Machinery
- Sill plate installation

RED HEAD® CONCRETE ANCHORS

CONCRETE ANCHORS



SLEEVE ANCHOR

VERSATILE ANCHORING SOLUTIONS FOR CONCRETE & BUILDING

Red Head can help you get any job done right, from heavy-duty ceiling applications to light-duty work in block and brick.

Our sleeve anchor is our most versatile anchor with the ability to fasten in block, brick, masonry, and solid concrete.

For a lighter duty project, Poly-Set and Hammer-Set are great choices for block, brick and concrete and allow for a quick and easy installation. For heavy-duty overhead applications, use our Drop-In anchors. Use the complete family of anchors and SDS bits to ensure precise hole depth and diameter when using our anchors.



POLY-SET



HAMMER-SET



DROP-IN

U.S (Std.) Size (Dia. x Length)	Pro Pack Part No.	Pro Pack Qty.	Handy Pack Part No.	Handy Pack Pail Qty.	Poly-Bag Part No.	Poly-Bag Qty.
SLEEVE ANCHORS						
1/4" x 2-1/4" Acorn Hd					50122	1
1/4" x 2-1/4" Threshold Hd					50123	1
1/4" x 3-1/8" Flat Hd					50121	1
5/16" x 1-1/2" Hex Hd					50112	1
5/16" x 2-1/2" Hex Hd					50113	1
3/8" x 1-7/8" Hex Hd					50114	1
3/8" x 3" Hex Hd	11281	50	11013	15	50115	1
1/2" x 2-1/4" Hex Hd					50116	1
1/2" x 3" Hex Hd	11283	25	11014	10	50117	1
1/2" x 4" Hex Hd	11285	25	11018	10	50118	1
5/8" x 4-1/4" Hex Hd					50119	1
5/8" x 6" Hex Hd					50120	1
POLY-SET ANCHORS						
1-1/4"			35220	50		
1-7/16"			35225	50		
HAMMER-SET ANCHORS						
1/4" x 1"	35300	75	35200	25		
1/4" x 1-1/2"	35303	50	35203	15		
1/4" x 2"	35305	50	35205	15		
1/4" x 3"	35207	25				
DROP-IN ANCHORS						
3/8" Anchor	01891	50			50125	1
1/2" Anchor					50126	1
3/8" Setting Tool					07499	1
1/2" Setting Tool					07501	1



APPLICATIONS:

- Conduit Clips
- Drywall tracks
- Curtain rods
- Shelving
- Shelf Ledgers
- Racking
- Secure Transformers
- Light Fixtures

A7+ ADHESIVE ANCHORS

HIGH STRENGTH ADHESIVE ANCHORING SOLUTION



CONCRETE ANCHORING AND REINFORCING SOLUTIONS

For jobs requiring versatility, high performance, and efficiency, Red Head's A7+ Concrete Adhesive Anchor is the one anchoring solution that does it all. A7+ takes only 45 minutes to fully cure and can be used in challenging conditions like cold temperatures and water-filled holes. A7+ is also ICC-ES approved for cracked concrete and seismic building code requirements.

- **ICC-ES approved** For use in cracked concrete and seismic conditions (ICC-ES-ESR-3903)
- **Quick 45 minute cure time** for fast installation
- **Easy dispensing** with a standard caulk gun, eliminating the need for any special tools
- Increased productivity with a successful cure in saturation concrete and water-filled holes
- A long-standing reputation for quality, strength, and ease of installation from industry professionals.



ESR-3903



ESR-3951

A7+ can also be used in any standard medium-duty caulk gun, eliminating the inconvenience of needing a special dispensing tool. Combine the simplicity of dispensing with the quick-curing product, and installation is fast, easy, and doesn't take time away from the rest of the project.

The A7+ concrete adhesive anchoring solution is a high-performing anchor that rivals other products on the market in both price and features. This high performance and efficiency allows for less time on the job and more productivity.

Providing code approved performance and a fast 45 minute cure time, Red Head A7+ is the concrete anchoring adhesive that delivers.

U.S (Std.) Size (Dia. x Length)	Part No.	Qty.
9.5 oz. Cartridge	07111	1



APPLICATIONS:

For use in:

- Concrete
- Grout-filled and hollow brick
- Clay tile



Cobra+



MasterShot



TriggerShot



HammerShot



ESR-1799



ESR-2690

DURABLE. STURDY. POWERFUL.

From concrete to steel, Ramset has the tool to help you get the job done on time. Ramset is designed with speed and productivity in mind. With innovative solutions we provide you with the best anchoring experience.

- **Powder actuated tools for concrete or steel**
- **Drives jobsite speed** through quick and efficient fastening
- **Market leading tool innovations** help you get the job done right
- The Powder Actuated Tool choice for PROs

Item/Tool	Part No.	Qty.
Cobra+ .27 Caliber Semi-Automatic Powder Actuated Tool	16942	1
MasterShot .22 Caliber Single-Shot Powder Actuated Tool	40088	1
TriggerShot .22 Caliber Single-Shot Powder Actuated Tool	40066	1
HammerShot .22 Caliber Single-Shot Powder Actuated Tool	00022	1

U.S (Std.) Size (Dia. x Length)	Pro Pack Part No.	Pro Pack Qty.	Handy Pack Part No.	Handy Pack Pail Qty.				
DRIVE PINS								
.300 x 1/2"	06171	100						
.300 x 3/4"	00747	100						
.300 x 1"	00759	100						
.300 x 1-1/2"	00774	100						
.300 x 2"	00780	100						
.300 x 2-1/2"	00786	100	00787	25				
.300 x 3"	00794	100						
DRIVE PINS WITH WASHERS								
.300 x 1"	00797	100						
.300 x 1-1/2"	00803	100	00804	25				
.300 x 1-1/4"	00800	100						
.300 x 2"	00806	100						
.300 x 2-1/2"	00809	100	00810	15				
.300 x 3"	07886	100	07887	15				
RAMGUARD DRIVE PINS FOR USE IN TREATED LUMBER								
.300 x 2-1/2"	09167	100						
.300 x 2-1/2" with Washers	09173	100						
.300 x 3" with Washers	09176	100						
Caliber	Color	Type	Strip Load Part No.	Qty.	Single Shot Box Pt. #	Single Shot Box Qty.	Single Shot Blister pt.#	Single Shot Blister Qty.
.22	Brown	Powder			00594	100		
.22	Green	Powder			00601	100		
.22	Yellow	Powder			00607	100	50077	25
.27	Green	Strip	00652	100				
.27	Yellow	Strip	00667	100				
.27	Red	Strip	00682	100				



APPLICATIONS:

- 2 x 4 framing
- Furring strips
- Attaching electrical boxes

Teks®

Teks was established in 1967 with the introduction of the original self-drilling screw. Since then, we have continued to innovate and provide value-added metal fastening solutions to the construction market.

We take pride in our commitment to operational excellence, superior service and new product development. That has guided the company through decades of growth by meeting the ever-changing needs of the residential/renovation construction industry. Focusing on the needs of our end-users enables us to optimize our product offering and service based on their requirements.





TEKS® METAL FASTENERS

ROOFING SCREWS



Teks Colored Roofing Screw

Teks Roofing Screw



Teks Elite Roofing Screw

TEKS ROOFING SCREWS

Teks Roofing Screws provide secure metal to metal fastening with strong holding power, without need to pre-drill.

- The **self-sealing neoprene washer** provides a waterproof seal.
- The **premium finish** provides exceptional corrosion resistance in harsh outdoor environments.

Teks colored roofing screws are designed for fastening colored metal roofing and siding panels for a perfect color match that provides a clean look and quality finish.

- **Full head paint coverage**
- Incorporates durable and long lasting liquid paint
- **High grade steel**
- **Weather tight seal**

The Elite screws are trusted for their superior drilling performance, fast installation and holding power – making them the go-to screw for pros who want unparalleled performance and superior results.

- **Maxiseal™ Washer:** Washer attached directly to head of screw for better waterproofing - even at an angle.
- **Shankguard™:** Improved under-roof corrosion resistance.
- **Hi-grip™* Threading:** Prevents water entry and over-drilling
*Not available on 1" screws
- **Climacoat Coating:** No streaking or rust from corrosion
- Comes in drill point and sharp point

U.S (Std.) Size (Dia. x Length)	Pro Pack Part No.	Pro Pack Pail Qty.	Handy Pack Part No.	Handy Pack Qty.
TEKS® ROOFING SCREWS				
HEX WASHER HEAD / SHARP POINT (METAL TO WOOD)				
9 x 1"	21401	360	21400	120
9 x 1-1/2"	21406	400	21404	100
HEX WASHER HEAD / DRILL POINT (METAL TO METAL)				
12 x 3/4"			21408	90
12 x 1"	21418	400	21412	80
12 x 1-1/2"	21422	300		
TEKS® COLORED ROOFING SCREWS (SHARP POINT)				
9 x 1-1/2" (Green)			21414	100
9 x 1-1/2" (White)			21424	100
TEKS® ELITE PREMIUM ROOFING SCREWS				
SHARP POINT				
10 x 1-1/2"	21453	300	21452	100
12 x 1"	21450	120		
DRILL POINT				
12 x 1"			21470	80
12 x 1-1/2"	21473	225	21472	75

APPLICATIONS



ROOFING SCREWS:

- Ideal for attaching metal roofing and siding
- Sharp point for use in metal to wood applications
- Drill point for use in metal to metal applications

TEKS® METAL FASTENERS

METAL TO METAL SCREWS



SECURELY FASTEN METAL WITH SPEED

Teks® fasteners are offered in sharp and drill points that easily penetrate light to heavy gauge metal and wood. Professionals no longer have to struggle when engaging their work surface.

Teks® fasteners are offered in a wide variety of head styles to meet professionals installation needs. No tool slippage or cam-outs even with old sockets and worn bits. Professionals can drill, tap, and fasten – all in one motion.

- **Drive surface and recess:** Reduces cam-outs to prevent slipping during installation
- **Drill Points:** Self-drills through light to heavy gauge metal with ease
- **Sharp Points:** Self-pierces into light gauge metal to start drilling faster
- **Self-Tapping Threads:** Taps their own threads to provide less effort when fastening into metal
- **Corrosion Resistant Finish:** Protects the job's appearance with long lasting coating

APPLICATIONS



METAL TO METAL:

- Attaching HVAC
- Electrical
- Metal framing
- General metal to metal applications

U.S (Std.) Size (Dia. x Length)	Pro Pack Part No.	Pro Pack Pail Qty.	Handy Pack Part No.	Handy Pack Qty.
TEKS® METAL TO METAL SCREWS				
HEX WASHER HEAD / DRILL POINT (METAL TO METAL)				
8 x 1/2"			21308	280
8 x 3/4"			21312	180
8 x 1"			21316	170
10 x 5/8"			21396	170
10 x 3/4"	21322	450	21320	150
10 x 1"			21328	140
10 x 1-1/2"			21332	90
12 x 3/4"			21336	120
12 x 1"	21341	400	21340	100
12 x 1-1/2"			21344	80
12 x 2"			21348	60
12/14 x 2"			21820	60
14 x 3/4"			21349	100
14 x 1"			21351	60
14 x 1-1/2"			21352	50
14 x 2-1/2"	21358	120	21356	30
HEX WASHER HEAD / SHARP POINT (METAL TO METAL)				
6 x 1/2"			21301	320
8 x 1-1/2"			21318	85
10 x 3/4"			21327	150
PAN HEAD / DRILL POINT (METAL TO METAL)				
8 x 1/2"			21360	300
8 x 3/4"			21364	240
10 x 3/4"			21372	170
PAN HEAD / SHARP POINT (METAL TO METAL)				
6 x 1/2"			21359	300
PANCAKE HEAD / DRILL POINT (METAL TO METAL)				
10 x 5/8"			21376	190

TEKS® METAL FASTENERS

LATH SCREWS AND WOOD TO METAL SCREWS



LATH SCREW



WOOD TO METAL SCREW

Teks Lath Screws provide secure metal-to-metal and metal-to-wood fastening with strong holding power, without the need to pre-drill.

- **Lath head:** Lath Screws feature a low-profile head for a semi-flush finish for virtually any application
- **Self-tapping threads:** Ensure strong holding power
- **Zinc plated finish:** Protects the job's appearance.

Teks Wood-to-Metal screws help you secure wood to metal without pre-drilling. The special wings ream a hole in the wood to prevent thread engagement during drilling; these wings break away when self-tapping into metal providing a secure hold.

- **Precision point with wings:** Designed to drill, tap, and fasten all in one motion
- **Climacoat premium coating:** Provides a long life finish for exterior applications
- **High performance drive:** Surfaces reduce cam-outs to penetrate surface the first time for easy installation
- **Wings:** Ream a hole in the wood to prevent thread engagement and break away when self-tapping into metal

APPLICATIONS



LATH SCREWS:

- Attaching lath to wood or steel studs for stucco/plaster applications
- Attaching pre-drilled metal brackets to post-framing
- Any general applications requiring a wide, low-profile head



WOOD TO METAL:

- Attaching roof/subfloor decking
- Attaching trailer beds to frame
- Attaching wood headers to steel frame

U.S (Std.) Size (Dia. x Length)	Pro Pack Part No.	Pro Pack Pail Qty.	Handy Pack Part No.	Handy Pack Qty.
TEKS® LATH SCREWS				
MODIFIED TRUSS HEAD / SHARP POINT (METAL OR LATH TO WOOD)				
8 x 1/2"			21500	260
8 x 3/4"	21506	600	21504	200
8 x 1"	21510	510	21508	170
8 x 1-1/4"			21512	140
8 x 1-5/8"			21516	120
8 x 2"			21518	100
8 x 2-1/2"			21519	80
MODIFIED TRUSS HEAD / DRILL POINT (LATH OR METAL TO METAL)				
8 x 1/2"			21520	260
8 x 3/4"	21525	600	21524	200
8 x 1"	21530	510	21528	170
8 x 1-1/4"			21532	140
8 x 1-5/8"			21536	120
8 x 2"			21538	100
8 x 2-1/2"			21540	80
TEKS® WOOD TO METAL SCREWS				
PHILLIPS FLAT HEAD / DRILL POINT W/REAMER WINGS (WOOD TO METAL)				
1/4-20 x 3"			21378	40
10 x 1-7/16"	21381	300	21380	100
12 x 2-3/4"	21386	200	21384	40

BACKER-ON[®], ROCK-ON[®]

CEMENT BOARD SCREWS

CEMENT BOARDS FASTENED RIGHT

Backer-On[®] cement screws are designed for attaching HardieBacker[®] cement board and Rock-On[®] cement board screws are designed for attaching Durock[®] cement board to wood or light gauge steel studs. The patented serrated head design countersinks for a flush finish even at angle, providing a smooth surface for tile installation. The T-25 Star Drive recess provides Stikfit™ for one-handed installation. Climacoat corrosion resistant finish prevents rust from bleeding into grout. Making it perfect for use in high moisture areas such as bathrooms and kitchens.

Backer-On[®] and Rock-On[®] cement board screws comply with ANSI standards for cement board installation as specified by cement board manufacturers. Cement board manufacturers require ANSI compliance in order to remain eligible for warranty.

- **Serrated Head:** Designed to drive flush even at an angle
- **Star Drive with T-25 Bit:** Provides Stikfit™ for easy one-handed installation and eliminates cam-outs
- **Hi-Lo / Single Threads:** Starts quickly and drives smooth in cement boards
- **Sharp Points:** Offers immediate pick-up and eliminates the need to pre-drill
- **Climacoat Finish:** Corrosion resistant for preventing rust from bleeding into tile



BACKER-ON® ROCK-ON®

U.S (Std.) Size (Dia. x Length)	Pro Pack Part No.	Pro Pack Pail Qty.	Handy Pack Part No.	Handy Pack Ctn. Size/Qty.
BACKER-ON® SCREWS				
#9 x 1-1/4"	23406	750	23401	M/185
#9 x 1-5/8"	23416	575	23411	M/140
#9 x 2-1/4"			23421	M/100
ROCK-ON® SCREWS				
#9 x 1-1/4"	23306	750	23301	M/185
#9 x 1-5/8"	23316	575	23311	M/140
#9 x 2-1/4"			23321	M/100
BACKER-ON® ROCK-ON® SCREWS				
#9 x 1-1/4"	23505	750	23500	M/185
#9 x 1-5/8"	23515	575	23510	M/140
#9 x 2-1/4"			23520	M/100

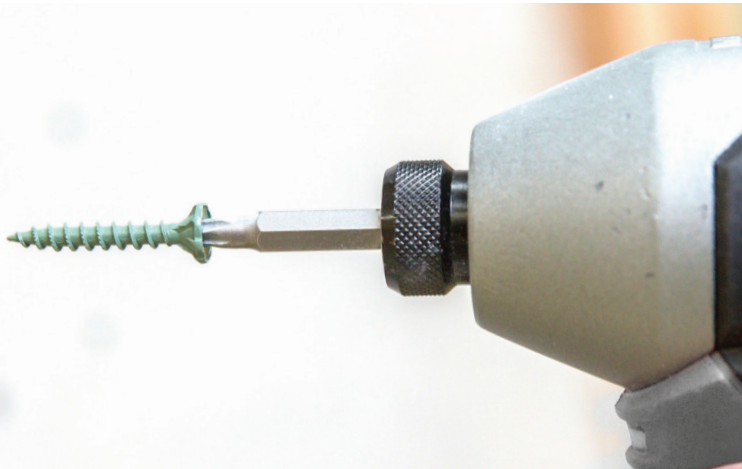

APPLICATIONS:

- Attaching fiber cement board to wood or light gauge steel framing
- Attaching fiberglass reinforced cement board to wood or light gauge steel framing

Pro Tip: Standard roofing nails, dry wall screws, and other alternatives to cement board screws are typically not specified by cement board manufacturers and not ANSI compliant.



E-Z Ancor® Twist-N-Lock



E-Z Ancor® Stud Solver



E-Z Ancor® Toggle Lock

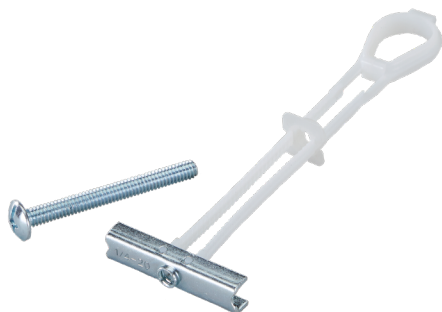

E-Z Ancor® Heavy Duty
Toggle Lock

EASY TO INSTALL WITH STRONG HOLDING POWER

E-Z Ancors® are ideal for hanging accessories, signs, fixtures, and shelving units on drywall. Designed to self-drill flush into drywall for easy and fast installations. No pre-drilling necessary. The threads are formed to provide increased stability and a secure hold.

E-Z Ancor® Twist-N-Lock is designed for light to medium-duty applications. The audible click provides confirmation of the anchor being firmly set. Threads cut deeply to resist pull-out and provide a secure hold.

E-Z Ancor® Stud Solver is designed for light to medium-duty applications. Installs anywhere on a wall, even if you hit a wood stud behind the drywall. Threads cut deeply to resist pull-out and provide a secure hold.

E-Z Ancor® Toggle Lock is designed for heavy-duty drywall applications. The superior 1-piece assembly prevents losing extra pieces behind the wall. The toggle bar swivels easily during assembly to provide a secure hold.

Buildex® Stucco Anchor is designed for light to medium-duty applications in stucco. The zinc plating is designed to be durable in exterior and interior applications. Kits include a drill bit for installation.

E-Z Ancor® Heavy Duty Drywall Toggle Anchors are designed for medium to heavy-duty hollow wall applications. The metal toggle bar clamps the wall providing an even and secure hold. The flexible plastic straps allow the toggle bar to swivel for easy installation.

- **No Pre-Drilling:** Screws directly into drywall with a Phillips screwdriver
- **Self-Piercing Point:** Positions anchor in desired location without slipping and starts self-drilling faster
- **Clean Finish:** Installs flush into drywall
- **Strong Holding Power:** Prevents loose connections and items from wobbling



U.S (Std.) Size (Max Load)	Lg. Pack Part No.	Lg. Pack Qty.	Med. Pack Part No.	Med Pack Qty.	Small Pack Part No.	Small Pack Qty.
E-Z ANCOR TWIST-N-LOCK ANCHORS						
50 lbs.	25350	50	25200	25	11353	6
75 lbs.	25310	50	25210	20	11364	4
E-Z ANCOR STUD SOLVER ANCHORS						
40 lbs.	25325	50	25225	25	25125	4
50 lbs.	25316	50	25216	20	29503	5
E-Z ANCOR / E-Z TOGGLE LOCK ANCHOR						
100 lbs.	25320	25	25220	10	10006	2
BUILDEX® STUCCO ANCHORS						
3/16"x 1-1/2"Hex Hd			31810	25	31710	4
3/16"x 1-1/2"Flat Hd			31820	25	31720	4
1/4"x 2-7/8"			31840	25	31740	4
E-Z ANCOR HEAVY DUTY TOGGLE ANCOR						
110 lbs. - 3/16" Bolt			25730	25	25720	10
120 lbs. - 1/4" Bolt			25731	25	25721	10

E-Z ANCOR CONTRACTOR PACKS		
U.S (Std.) Size (Max Load)	Contractor Pack Part No.	Contractor Pack Qty.
E-Z ANCOR CONTRACTOR TWIST-N-LOCK ANCHORS		
75 lbs.	25410	100
E-Z ANCOR CONTRACTOR STUD SOLVER ANCHORS		
50 lbs.	25616	100
E-Z ANCOR TWIST-N-LOCK AND STUD SOLVER ANCHORS COMBO		
50 lbs./75 lbs.	25600	25/25

Warning: Do not use Twist-N-Lock or Stud Solver anchors for ceiling applications. Do not use for mounting televisions. Load ratings are for items hung flush to the wall. Load ratings decrease when hanging items that project from the wall.



APPLICATIONS:

For Mounting:

- Picture Frames
- Shelving
- Mounting Brackets
- Hooks
- And more

LIABILITY AND WARRANTIES

Mechanical Fastening Warranty: (Includes GRK Fasteners, Tapcon, Red Head, Ramset, Teks, Rock-On, Backer-On, and E-Z Anchor). ITW Brands warrants that these products are free from defects in material and workmanship. ITW Brands's sole liability for any breach of this warranty shall be to replace this product or refund the purchase price.

Liability: Claims against GRK or ITW Brands shall be limited to a refund or credit for the price billed or paid for faulty or incorrect merchandise. Seller shall not be responsible for buyer's manufacturing costs, labor, alternate purchases, extra freight, replating, plating, lost profit, good will, recall costs, or other incidental or consequential damages.

Refunds/Replacements: In order to request a refund or replacement, please contact ITW Customer Service at BrandsCS@itwbrands.com or 877 489-2726 to start the process.

THERE ARE NO UNDERSTANDINGS, AGREEMENTS, REPRESENTATIONS, OR ADDITIONAL WARRANTIES, EXPRESSED OR IMPLIED (INCLUDING ANY REGARDING WARRANTIES OF MERCHANTABILITY OR FITNESS FOR A PARTICULAR PURPOSE), NOT SPECIFIED HEREIN, RESPECTING ANY SALE OF PRODUCTS BY GRK FASTENERS™ (TO THE EXTENT PERMITTED BY LAW).

LIABILITY AND WARRANTIES

GRK Fasteners™ (“GRK”) is a distributor of commercial-grade fasteners. The parts that we supply are quality inspected by independent labs.

We maintain lot traceability on all products listed in this catalog as long as they are in their original bulk boxes. Certifications are maintained on all fasteners.

Hydrogen Embrittlement: GRK takes measures during production of all fasteners to mitigate hydrogen embrittlement, including post-coating baking. These processes, however, do not guarantee that hydrogen embrittlement will not still be present or that it will not occur at a later date while in service. Specialized testing or a substitute part may be required, depending on the application.

GRK Warranty: GRK warrants to the first retail purchaser that its Climatek™ coated, Deck Elite coated, and PHEINOX™ stainless steel screws will not rust under normal environmental conditions when used in accordance with the recommendations listed in this catalog. This warranty is not transferable. Visit www.grkfasteners.com for more information.



paslode.com



grkfasteners.com



tapcon.com



backeronrockon.com



ramsetpat.com



teksscrews.com



redheadanchoring.com



easyanchors.com

FULL-LINE CATALOG



Part #99915
August 2023

ITW CONSTRUCTION | RESIDENTIAL AND RENOVATION
Glenview, IL 60025